



Audi

A3

Sportback



Exhilaration scaled to size.

What could accelerate your heart rate more than a car with the grip and performance of quattro®? That's what we thought too. We've poured as much technology, performance and luxury as one could into the A3, which makes it a bit unfair to compare it to other cars.

**Resist the temptation to hold
your hands over your head.**





A3. Standard Equipment

1. Four-spoke leather-wrapped steering wheel | The four-spoke leather-wrapped steering wheel provides a sporty look and feel, enhancing the A3 driving experience.

2. Standard equipment for 2.0 T
17" five-spoke alloy wheel with 225/45 all-season tires | The 17" five-spoke alloy wheel is equipped with all-season tires, helping to ensure a safe and comfortable ride on virtually all driving surfaces.

3. Standard equipment for 3.2
17" ten-spoke alloy wheel from quattro® GmbH with 225/45 all-season tires | The stylish 17" ten-spoke wheel matches the sporty design of the A3. The all-season tires help ensure a safe and comfortable ride on virtually all driving surfaces.

4. Driver information system | At the center of the instrument cluster is the driver information system with trip computer. Here, the driver has access to an array of data, including outside temperature, real-time fuel economy, remaining miles per tank and other valuable information.

5. Audi Concert with SIRIUS® Satellite Radio | The Audi Concert features a new auxiliary audio input, digital AM/FM stereo and a single-disc CD player with MP3 playback capability. The addition of SIRIUS® Satellite Radio offers a wide variety of commercial-free music channels.

+ Cruise control | This electronic aid stores and maintains the speed selected by the driver. Also included are coast, resume and acceleration features, which all help to reduce stress on the driver.

+ Leather seating surfaces | The superior quality of leather and its impeccable craftsmanship add to the elegant, dynamic and versatile driving experience of the A3.

+ Feature not shown.



+ Dual-zone automatic climate control | The climate is easily controlled through the center console, while a light sensor on the dashboard adjusts the system based on the sun's intensity.

+ ESP® | The Electronic Stabilization Program [ESP®] helps make the vehicle easier to control in adverse conditions or when the car is at its handling limit. Helping to reduce the danger of swerving and improving directional stability, the program identifies the car's intended direction and response.

+ Tire pressure monitoring | The tire pressure monitoring system notifies the driver when tire pressure is above or below acceptable levels. It oversees the pressure in all four tires while the car is being driven and warns the driver in the event of pressure loss with symbols in the driver information system.

+ Space-saver spare wheel | The space-saver spare wheel complements the compact design of the A3 and optimizes the use of space in this sporty and versatile vehicle.

+ Folding armrest | The full-length, front center armrest features a storage area under the padded armrest cover and two twelve-volt power outlets within the console.

A3. Premium Package



1. 17" ten-spoke alloy wheel with 225/45 all-season tires | The ten-spoke alloy wheel gives the A3 an aggressive look, while the all-season tires help ensure a safe and comfortable ride on virtually all driving surfaces.

2. Aluminum belt line trim | The stylish aluminum belt line trim accents the overall interior excellence of the Audi A3.

3. Front fog lights | The front fog lights help illuminate the road as well as improve your visibility to oncoming drivers in inclement weather.

4. Three-spoke multifunction leather steering wheel | The three-spoke, leather-covered multifunction steering wheel provides easy access to infotainment functions.

+ Illumination Package | The interior lighting package features permanent vertical ambient illumination of controls and the center console for reliability and orientation in these areas.

+ Feature not shown.

+ Storage Package | The comprehensive storage system provides ample and convenient spaces for a wide variety of storage needs, including side pockets, floor tiedowns and bag hangers.

+ Bluetooth® | The Bluetooth® hands-free phone interface allows you to pair a Bluetooth®-enabled mobile phone with your Audi and access your phonebook within the driver information system in your instrument panel. For specific compatibility and operation instructions, refer to audiusa.com/bluetooth or contact your local Audi dealer for the latest listing of compatible phones.

+ Power front driver seat | The power front seat allows the driver to adjust the seat's fore/aft position, height, lumbar support and angle of seat cushion and seat back.

Premium Package is not available with S line Package.

A3. S line Package



Sport Package wheel shown.



1. Exterior features | The visually compelling features in the S line Package include more aggressive front and rear bumpers with dynamic air inlets, rear diffuser and rear roof spoiler. S line badges are applied to the front fender panels and door sill trim.

2. Three-spoke multifunction leather steering wheel | The three-spoke, leather-covered multifunction steering wheel provides easy access to infotainment functions.

3. Interior features | S line interior touches are anchored with brushed aluminum inlays throughout the cockpit, extending into the rear.

4. Illumination Package | The interior lighting package features permanent vertical ambient illumination of controls and the center console for reliability and orientation in these areas.

+ 17" ten-spoke alloy wheel with 225/45 all-season tires | The stylish 17" ten-spoke wheel matches the sporty design of the A3. The all-season tires help ensure a safe and comfortable ride on virtually all driving surfaces.

+ Bluetooth® | The Bluetooth® hands-free phone interface allows you to pair a Bluetooth®-enabled mobile phone with your Audi and access your phonebook within the driver information system in your instrument panel. For specific compatibility and operation instructions, refer to audiusa.com/bluetooth or contact your local Audi dealer for the latest listing of compatible phones.

+ Feature not shown. S line Package is not available with Premium Package.

A3. Options

Convenience Package Standard for 3.2

- 1. BI-XENON™ headlights** | BI-XENON™ headlights produce a bright arc that serves as an excellent light source to illuminate the road. LED daytime running lights provide safety, visibility and can be switched off manually if necessary.
 - 2. BOSE® Premium Sound System** | The ten-speaker sound system is individually tailored to the A3 interior. It is further enhanced by the AudioPilot® noise compensation feature.
 - 3. Auto-dimming interior mirror with compass** | The rearview mirror with compass recognizes distracting bright light behind the car and darkens the mirror glass automatically.
- + **Rain/light sensor** | An embedded sensor detects the level of light and automatically turns on the headlights if needed. The rain sensor offers the same convenience when it comes to precipitation by automatically adjusting the rate of the wiper sweep to the amount of rain.

Sport Package

- 4. Sport seats** | The sport seats offer greater lateral support thanks to more prominent side sections.
- + **Sport suspension** | For those who plan to drive in a more sporty fashion, the Sport Package includes a specially tuned, firmer MacPherson strut front suspension.
 - + **18" five-tri-spoke alloy wheel with 225/40 summer performance tires*** | The five-tri-spoke alloy wheel with summer performance tires allow for improved driving dynamics and superior handling in warm conditions.

+ Feature not shown.



Titanium Package

- + **18" seven-double-spoke titanium color cast alloy wheel with 225/40 summer performance tires*** | The titanium color cast alloy gives the A3 an impressive wheel option. This sporty tire focuses on performance.
- + **Black headliner** | The unique black headliner dominates the interior of the A3, adding to the comfortable and sporty driving experience.
- + **Black grille and exterior trim** | The black front grille adds a unique touch to the exterior of the A3. A beautiful complement to the dynamic lines of this sporty vehicle, the grille gives the exterior a design that is as impressive as the ride.
- + **Piano black interior inlays** | The sleek elegance of the piano black interior inlays extending across the dash and doors underlines the quality and craftsmanship of the A3 interior.

Cold Weather Package

- + **Heated front seats** | The multilevel seat heating system is designed to heat the seat and can be initiated with a convenient six-step rolling wheel.
- + **Heated windshield washer nozzles** | The heated windshield washer nozzles give the A3 enhanced convenience.
- + **Heated exterior mirrors** | The heated exterior side view mirrors give the driver extra convenience by reducing fog and ice.

*See page 22 for important safety information regarding summer performance tires.

A3. Stand Alone Options



1. Open Sky sunroof | The easy-to-operate glass sunroof provides the driver and passengers of the A3 with natural light and a continuous flow of fresh air within the cabin. The Open Sky system includes a large two-piece panorama sunroof for a refreshingly airy driving experience.

2. Audi Navigation system and glove box six-CD changer | The DVD-based Audi Navigation system features a full-color 6.25" LCD screen and MMI® – inspired control logic for AM/FM radio functions, a six-CD changer in the glove box, two SD® card slots for your MP3 music and auxiliary audio input.

+ Audi magnetic ride suspension | Instead of conventional damper oil, the shocks are filled with a special fluid, where viscosity can be controlled by an electromagnetic field. The A3 harnesses the fluid's electromagnetic properties to deliver the appropriate damping forces. It operates in normal or sport mode.

+ Rear side airbags* | The A3 offers rear side airbags, which can help reduce the risk of severe injuries in certain collisions.

+ Feature not shown.



*Airbags are supplemental restraints only, and will not deploy under all crash circumstances. Always use safety belts and seat children in the rear, using restraint systems appropriate for their size and age.

A3. Wheels

They look good parked.
They look even better blurry.

1. Standard A3 2.0 T Wheel

17" five-spoke alloy wheel with 225/45 all-season tires | The 17" five-spoke alloy wheel is equipped with all-season tires, helping to ensure a safe and comfortable ride on virtually all driving surfaces.

2. Standard A3 3.2 Wheel

17" ten-spoke alloy wheel from quattro® GmbH with 225/45 all-season tires | The stylish 17" ten-spoke wheel matches the sporty design of the A3. The all-season tires help ensure a safe and comfortable ride on virtually all driving surfaces.

3. Optional A3 2.0 T Wheel [Premium Package and S line Package]

17" ten-spoke alloy wheel with 225/45 all-season tires | The ten-spoke alloy wheel gives the A3 an aggressive look, while the all-season tires help ensure a safe and comfortable ride on virtually all driving surfaces.

4. Optional A3 Sport Package Wheel

18" five-tri-spoke alloy wheel with 225/40 summer performance tires* |

The five-tri-spoke alloy wheel with summer performance tires allows for improved driving dynamics and superior handling in the A3 model.

5. Optional Titanium Package Wheel

18" seven-double-spoke titanium color cast alloy wheel with 225/40 summer performance tires* | The titanium color cast alloy gives the A3 an impressive wheel option. This sporty wheel focuses on performance.

* Summer performance tires are designed for optimum performance and handling in warm climates. They are not suitable for cold, snowy or icy weather conditions. If you drive under those circumstances, you should equip your vehicle with all-season or winter tires, which offer better traction under those conditions. We suggest you use the recommended winter or all-season tires specified for your car or their equivalent. These summer performance tires also have a lower aspect ratio that aids performance and handling; however, in order to avoid tire, rim or vehicle damage, it is important that the inflation pressure is regularly checked and maintained at recommended levels. Serious wheel and tire damage may occur if the vehicle is operated on rough or damaged road surfaces, or upon encountering road debris or obstacles. Please also remember in making your selection that, while these tires deliver responsive handling, they may ride less comfortably and make more noise than other choices. Finally, these tires may wear more quickly than other choices. For more information on all of these topics, please consult the owner's manual or your local dealer or call 1-800-FOR-AUDI.



A3. Interior Seating and Decorative Inlay Options

Piano Black Inlay [Titanium Package]



Brushed Aluminum Inlay [S line]



Aluminum Medial Inlay [Premium Package]



Flexmetallic Inlay



Black

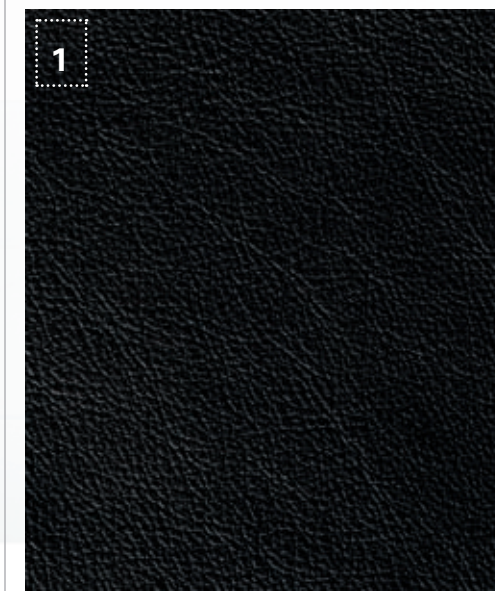

Brushed Aluminum Inlay [S line]



Aluminum Medial Inlay [Premium Package]



Flexmetallic Inlay



Light Gray



Brushed Aluminum Inlay [S line]



Aluminum Medial Inlay [Premium Package]



Flexmetallic Inlay



Luxor Beige



A3. Make Yours.



A3. Brilliant Black

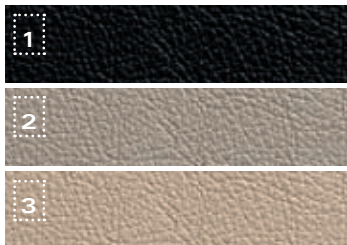

A3. Brilliant Red

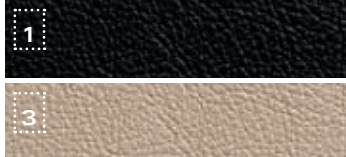

A3. Aruba Blue pearl effect¹



A3. Meteor Gray pearl effect¹

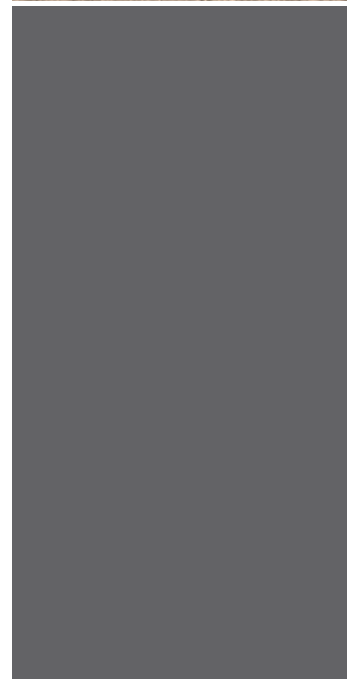
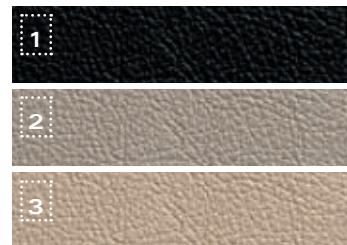

A3. Ibis White

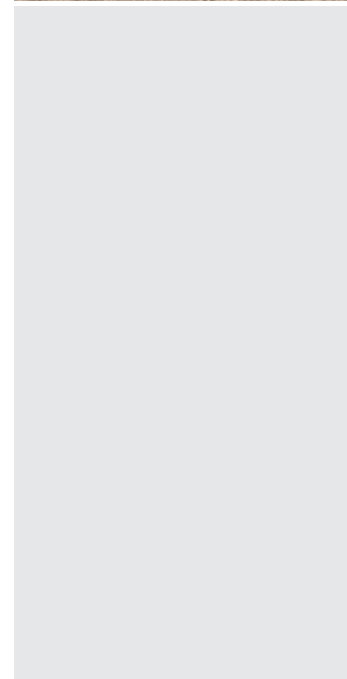
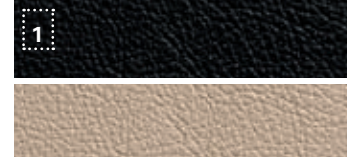

A3. Lava Gray pearl effect¹

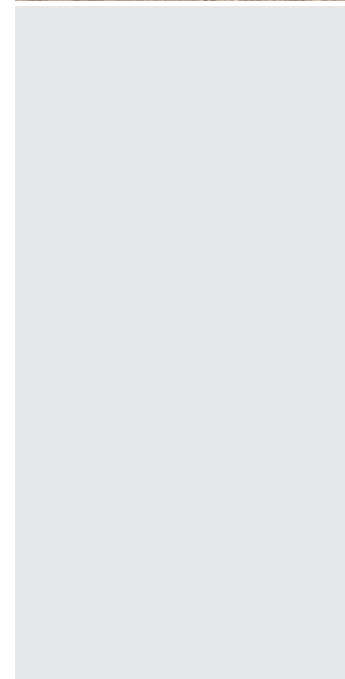
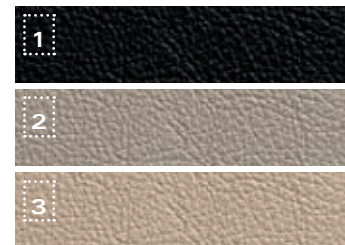

A3. Ice Silver metallic¹

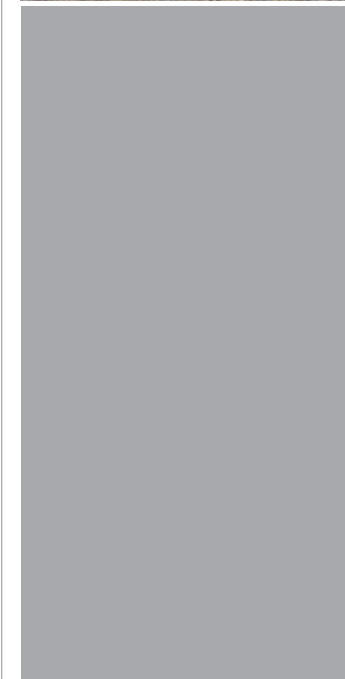
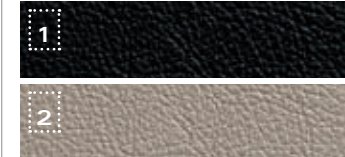

A3. Misano Red pearl effect^{**1}

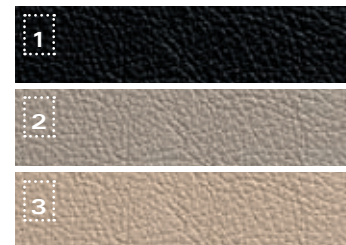

A3. Monza Silver pearl effect^{**1}

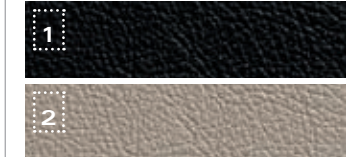

* Exterior color available with S line Package only
¹ Additional charge

A3. Specifications

The sum of some very impressive details.

A3 2.0 T	A3 3.2	Suspension/Body
S	S	Front suspension: MacPherson struts, aluminum subframe, tubular anti-roll bar
S	S	Rear suspension: four-link suspension with separate spring/shock absorber arrangement
S	S	Electromechanical steering with speed-dependent power assistance; turning circle: 35.1 ft.
S	S	Two-sided fully galvanized body, multistep anti-corrosion protection

A3 2.0 T	A3 3.2	Safety & Security
S	S	Electronic Stabilization Program [ESP®]
S	S	Anti-lock brake system with vacuum power assist, Electronic Brake-pressure Distribution [EBD], Electronic Differential Lock [EDL], hydraulic brake assist
S	S	Sideguard™ head protection airbags* for front and rear occupants
S	S	Driver and front passenger airbag*
S	S	Driver and front passenger seat-mounted chest side airbags*
S	S	Front three-point safety belts with automatic pre-tensioning, height-adjustable upper mounts and force limiters
S	S	Three rear three-point safety belts with automatic pre-tensioning
S	S	Front passenger and rear safety belts with convertible locking retractors
S	S	Power central locking system with safety unlock feature if airbag deploys
S	S	Tire pressure monitoring system
S	S	Lower Anchors and Tethers for Children [LATCH] in rear seats
S	S	Child safety rear door locks
S	S	Audi hill hold assist
S	S	Reflectors in rear of all doors
S	S	Anti-theft vehicle alarm system

* Airbags are supplemental restraints only, and will not deploy under all crash circumstances. Always use safety belts and seat children in the rear, using restraint systems appropriate for their size and age.

** Your Audi vehicle is equipped with a phone preparation utilizing Bluetooth® interface to enable hands-free functionality [compatible mobile phones sold separately]. You will need a Bluetooth®-enabled mobile phone in order to utilize this function. Not all Bluetooth®-enabled mobile phone models are compatible with Audi's phone preparation. Visit audiusa.com/bluetooth, or contact your local Audi dealer for the latest listing of compatible phones. Audi recommends use of the Audi phone cradle [sold separately] with your mobile phone while operating this vehicle.

† Audi Navigation plus depends on signals from the worldwide Global Positioning Satellite network. The vehicle's electrical system, and existing wireless and satellite technologies, must be available and operating properly for the system to function. The system is designed to provide you with suggested routes in locating addresses, destinations and other points of interest. Changes in street names, construction zones, traffic flow, points of interest and other road system changes are beyond the control of Audi of America, Inc. Complete detailed mapping of lanes, roads, streets, toll roads, highways, etc., is not possible, therefore you may encounter discrepancies between the mapping and your actual location. Please rely on your individual judgement in determining whether or not to follow a suggested Audi Navigation plus route. Periodically, the mapping is updated, and a new DVD will be required in order to maintain the latest navigation information available to us. These will be available for purchase from time to time at additional cost. Consult your dealer or call 1-800-FOR-AUDI for details.

A3 2.0 T	A3 3.2	Features
S	-	17" five-spoke alloy wheel with 225/45 all-season tires
-	S	17" ten-spoke alloy wheel from quattro® GmbH with 225/45 all-season tires
S	S	Power rear window wiper
S	S	Black trim around side window
S	S	Halogen headlights
S	S	Side indicator lights located in exterior mirrors
S	S	SIRIUS® Satellite Radio
S	S	Audi Concert AM/FM stereo with in-dash CD/MP3 player, Radio Data System [RDS] and Graduated Audio Level Adjustment [GALA]
S	S	Ten-speaker sound system, including subwoofer and center fill speaker
S	S	Trip computer
S	S	Electronic cruise control with coast, resume and acceleration features
S	S	Electric rear window defogger with automatic timed shut-off feature
S	S	Radio frequency remote locking system with selective unlock, remote decklid opening, panic function, interior lights and alarm system activation – control integrated in folding ignition key
S	S	Retained accessory power after key is removed from ignition
S	S	Backlit instrument cluster with automatic brightness control, including tachometer, electronic speedometer, odometer, voltmeter, digital clock with date, service interval indicator, fuel and coolant temperature gauges
S	-	Flexmetallic decorative inlays in center console and door panels
-	S	Brushed aluminum decorative inlays from quattro GmbH
S	S	Full-length center console with storage area and two built-in cupholders
S	S	Folding rear center armrest with cupholders
S	S	Illuminated glove box, rear cargo area, lighter and ashtray
S	S	Manually adjustable tilt-and-telescoping steering column
S	-	Four-spoke leather-wrapped multifunction steering wheel [includes paddle shifters on S tronic™ models]
S	S	Leather seating surfaces
S	-	Manually adjustable driver and front passenger seats
S	S	60/40 split-fold rear seat
O	S	Eight-way power driver's seat, including four-way power lumbar adjustment and manual passenger seat with height adjustment

†† Summer performance tires are designed for optimum performance and handling in warm climates. They are not suitable for cold, snowy or icy weather conditions. If you drive under those circumstances, you should equip your vehicle with all-season or winter tires, which offer better traction under those conditions. We suggest you use the recommended winter or all-season tires specified for your car or their equivalent. These summer performance tires also have a lower aspect ratio that aids performance and handling; however, in order to avoid tire, rim or vehicle damage, it is important that the inflation pressure is regularly checked and maintained at recommended levels. Serious wheel and tire damage may occur if the vehicle is operated on rough or damaged road surfaces, or upon encountering road debris or obstacles. Please also remember in making your selection that, while these tires deliver responsive handling, they may ride less comfortably and make more noise than other choices. Finally, these tires may wear more quickly than other choices. For more information on all of these topics, please consult the owner's manual, your local dealer or call 1-800-FOR-AUDI.

A3 2.0 T	A3 3.2	Features
S	S	Fully automatic dual-zone climate control system with sun sensor and activated charcoal filter
S	S	Power windows with power retention, "one touch up," "one touch down" and pinch protection for all windows
S	S	"Soft touch" opening for rear decklid
S	S	Twelve-volt power outlet
S	S	Cargo cover
S	S	Space-saver spare wheel
S	S	Seating capacity: five passengers
O	O	Open Sky system
O	O	Audi magnetic ride suspension
O	O	Audi Navigation system plus; glove box six-CD changer
O	O	Rear side airbags*
O	O	Northeast trading region emission requirements
O	O	California emission requirements
O	O	Metallic or pearl effect exterior paint
O	-	Premium Package: three-spoke multifunction leather steering wheel [with shift paddles on S tronic™], power front driver seat [includes four-way power lumbar], Bluetooth® hands-free phone interface,† Illumination Package, Storage Package, aluminum belt line trim, front fog lights, 17" ten-spoke alloy wheel with 225/45 all-season tires
O	S	S line Package: three-spoke multifunction leather steering wheel [with shift paddles on S tronic], power front driver seat [includes four-way power lumbar], Bluetooth® hands-free phone interface,† Illumination Package, Storage Package, Front fog lights, 17" ten-spoke alloy wheels with 225/45 all-season tires, brushed aluminum trim from quattro GmbH, S line front and rear bumper, roof spoiler, S line door sill inlays
O	S	Convenience Package: auto-dimming interior mirror with compass, Rain/Light sensor, BI-XENON™ headlights, BOSE® Premium Sound System
O	O	Sport Package: sport seats, sport suspension, 18" five-tri-spoke alloy wheel with 225/40 summer performance tires††
O	O	Cold Weather Package: heated front seats, heated windshield washer nozzles, heated exterior mirrors
O	O	Titanium Package: 18" seven-double-spoke titanium color cast alloy wheel with 225/40 summer performance tires;† black grille and exterior trim, black headliner, piano black decorative inlays

-	Not Available	S	Standard	O	Option
---	---------------	---	----------	---	--------

A3. Specifications



A3. Model Configurations

- Audi A3 2.0 TFSI 200 hp with six-speed S tronic™ transmission
- Audi A3 2.0 TFSI 200 hp with six-speed manual transmission
- Audi A3 2.0 TFSI 200 hp with six-speed S tronic™ transmission and quattro® all-wheel drive
- Audi A3 3.2 S line 250 hp with six-speed S tronic™ transmission and quattro® all-wheel drive

Power and Performance

A3 2.0 T

- | 200 hp – DOHC in-line 2.0 liter four-cylinder with FSI® Direct Injection, variable valve timing, intake manifold and exhaust turbocharger with intercooler
- | Displacement: 121.06 cu. in.
- | Bore: 3.25 in. Stroke: 3.65 in. Compression ratio: 10.3:1
- | Horsepower: 200 hp @ 5100-6000 rpm
- | Torque: 207 lb.-ft. @ 1800-5000 rpm
- | 0-60 mph in seconds: 6.7
- | Top track speed*: 130 mph
- | Fuel economy estimates, city/highway** – A3 S tronic™: 22/28 mpg; A3 S tronic™ quattro: 21/28 mpg; A3 manual: 21/30 mpg

A3 3.2 S line

- | 250 hp – DOHC spark ignition, front-mounted transverse 3.2 liter V6 engine and variable valve timing
- | Displacement: 190.57 cu. in.
- | Bore: 3.31 in. Stroke: 3.78 in. Compression ratio: 11.3:1
- | Horsepower: 250 hp @ 6300 rpm
- | Torque: 236 lb.-ft. @ 2750 rpm
- | 0-60 mph in seconds: 5.9
- | Top track speed*: 130 mph
- | Fuel economy EPA estimates, city/highway** – 18/25 mpg

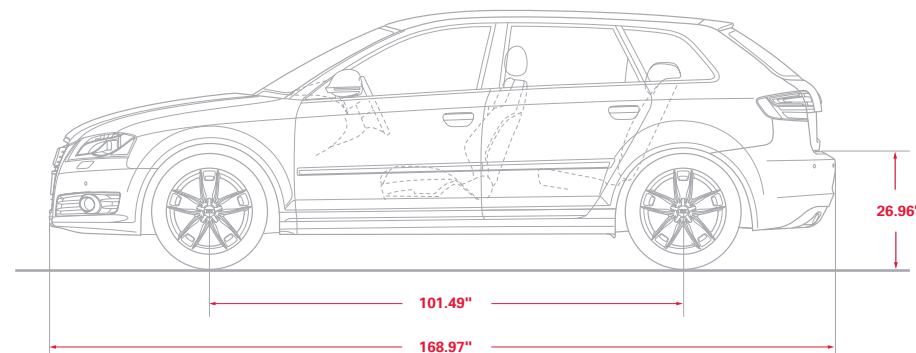
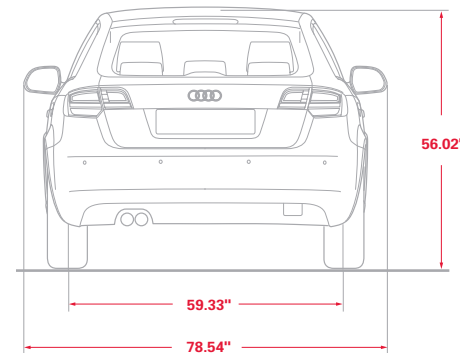
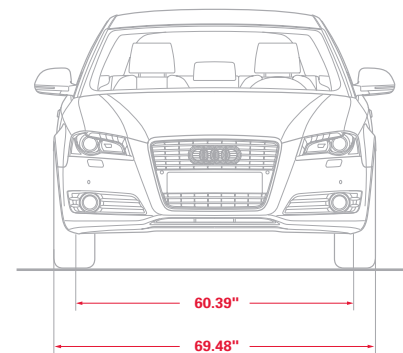

A3. Technology

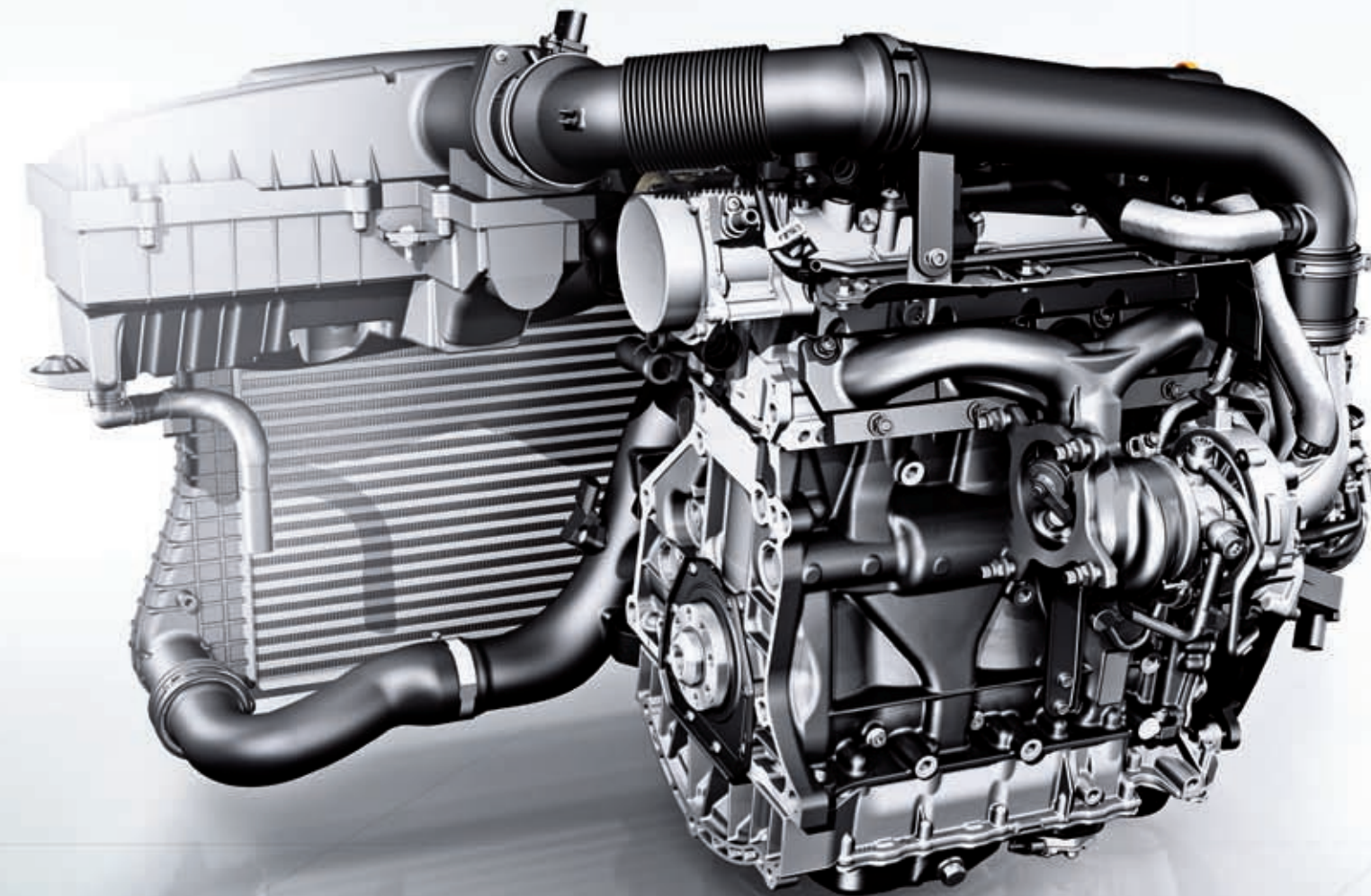

FSI® Direct Injection

This technology increases the torque and power of the engine, making it more economical,* as well as reducing exhaust emissions. More power, better economy and reduced emissions. It's a win-win-win for everyone.



Audi Magnetic Ride

Offering two ride variables, "Normal" and "Sport," Audi magnetic ride automatically adapts to prevailing conditions by magnetically charged hydraulic fluid that reacts to prescribed electrical charges, instantaneously adjusting damping rates.

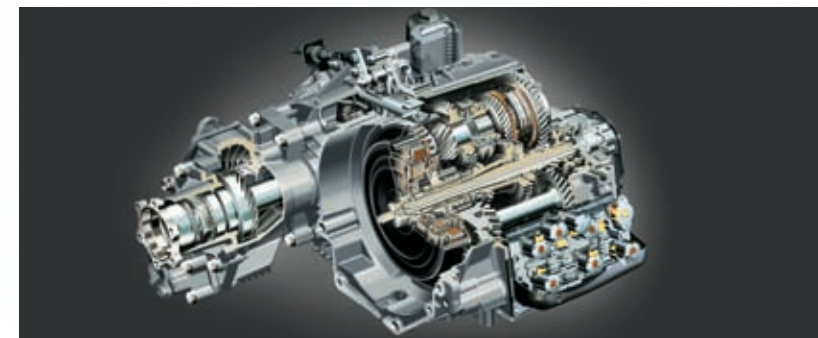

S tronic™ Transmission

The available S tronic™ in the A3 enables rapid-fire shifts, thanks to a double clutch system. Shifts can be engaged either through the shift lever on the console or by paddles located behind the steering wheel at 9 and 3 o'clock. Additionally, there are also two automatic driving mode options, "Normal" and "Sport," which allow the driver to further customize their drive.



quattro®

Developed and continually refined by Audi, quattro® offers a significantly enhanced level of all-wheel drive performance. In normal conditions, quattro® offers superior performance. And in the worst of conditions, it becomes simply superlative.

* Fuel economy estimates city/highway: 22/28 mpg [Audi A3 2.0 T] EPA estimate: your mileage may vary.

A3. Safety

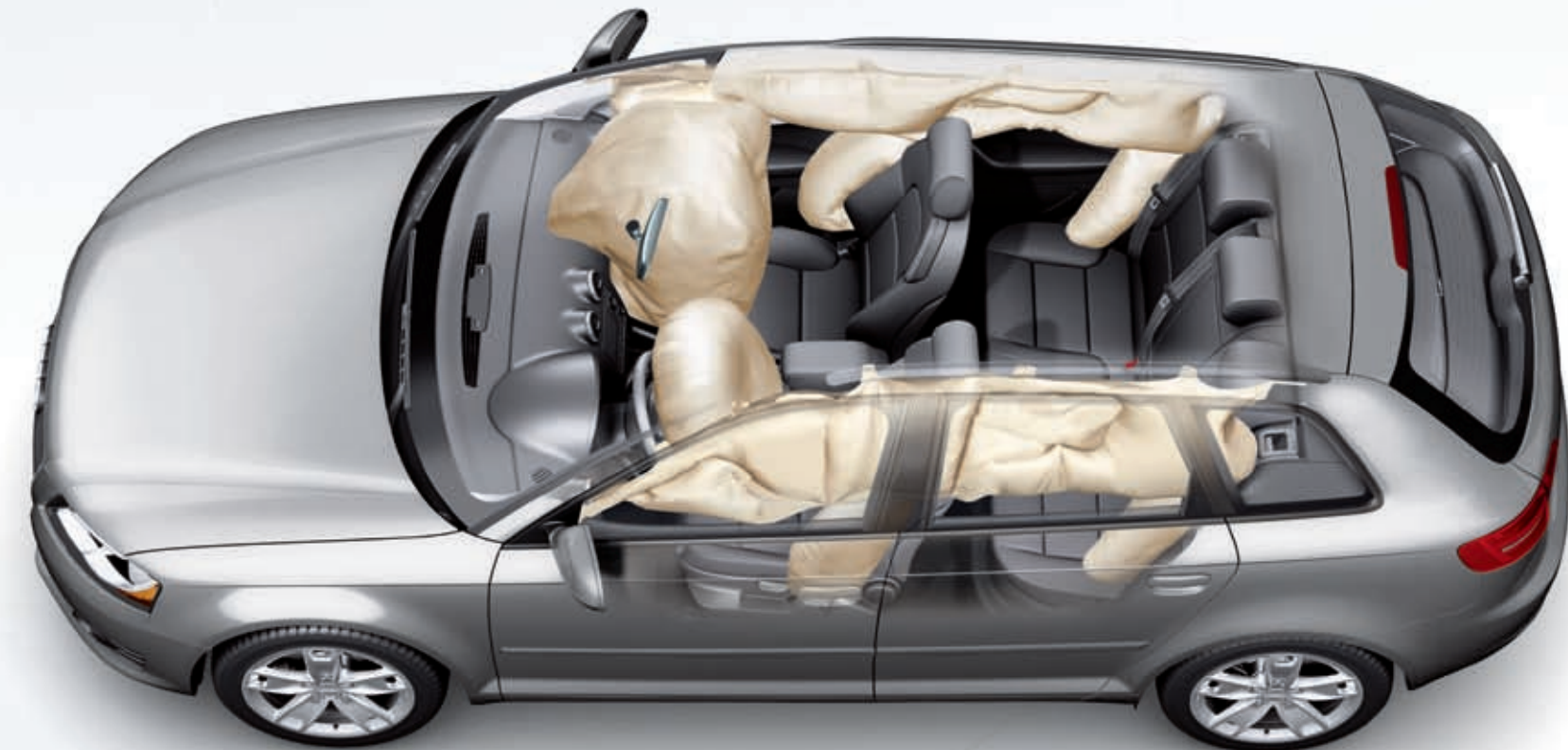

Exhilaration has a safe side.

At Audi, we believe the best way to deal with accidents is to avoid them in the first place. And that's why we've devoted more technology and inspired thinking, keeping you out of harm's way in the first place. However, some situations are unavoidable.



Airbags

The A3 offers a comprehensive supplemental restraint system of dual front passenger and driver airbags,* as well as Sideguard™ airbags that extend the length of the window area. No wonder it received the 2008 Top Safety Pick Award from the Insurance Institute for Highway Safety [IIHS].**

Without ESP®

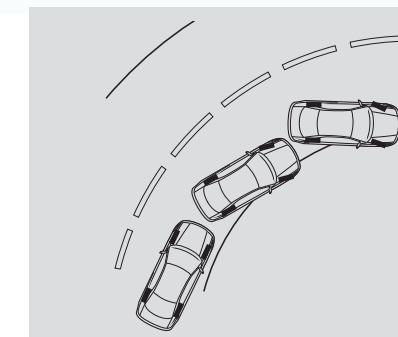

With ESP®

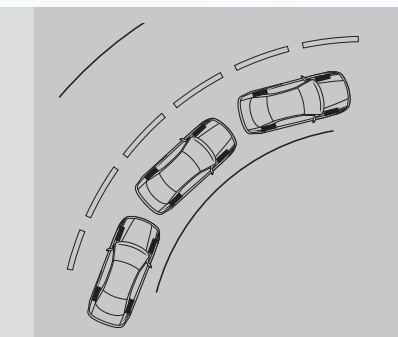

ESP®

ESP® allows your Audi to maximize control in adverse conditions, or where it may be at its handling limit. By employing a number of safety systems, including ABS [Anti-Lock Braking], EBD [Electronic Brake-pressure Distribution], EDL [Electronic Differential Lock] and ASR [Traction Control], in a fraction of a second, your A3 helps you avoid many dangerous driving scenarios.

* Airbags are supplemental restraints only, and will not deploy under all crash circumstances. The illustration shown is a dramatization of airbag deployment; not all airbags deploy during a crash. Always use safety belts and seat children in the rear, using restraint systems appropriate for their size and age.
** The Insurance Institute for Highway Safety is a non-profit research and communications organization funded by auto insurers. The Institute's research focuses on countermeasures aimed at all three factors in motor vehicle crashes [human, vehicular and environmental] and on interventions that can occur before, during and after crashes to reduce losses. For more information, visit iihs.org.



audiusa.com

2009 A3 Sportback

**If all of this wasn't enough to convince you,
perhaps a visit to your nearest dealer will.**

Note: A word about this brochure. Audi of America, Inc. believes the specifications in this brochure to be correct at the time of printing. However, specifications, standard equipment, options and colors are subject to change without notice. Some equipment may be unavailable when your vehicle is built. Please ask your dealer for advice concerning current availability of standard and optional equipment and verify that your vehicle will include the equipment you ordered. Vehicles in this brochure are shown with optional equipment. Tires supplied by various manufacturers. "Truth in Engineering" is a trademark of Audi of America, Inc. "Audi," "quattro," "A3," "FSI," the four rings and Audi emblems are registered trademarks of AUDI AG. "S tronic" is a registered trademark of AUDI AG. "Alcantara" is a registered trademark of Alcantara S.P.A. "ESP" is a registered trademark of DaimlerChrysler AG. "HomeLink" is a registered trademark of Prince Corporation, Holland, Michigan. Prince is a wholly owned subsidiary of Johnson Controls". "SIRIUS" is a registered trademark of SIRIUS Satellite Radio, Inc. "Bluetooth" is a registered trademark of Bluetooth SIG. "iPod" is a registered trademark of Apple Computer, Inc. "BI-XENON" is a trademark of Hella USA.

©2008 Audi of America, Inc.